

RPower OGiV121000LP (12V 100Ah AGM Battery)

Floating Life at 20°C designed for 10-12 years

EAN: 4260349823432

Dimensions

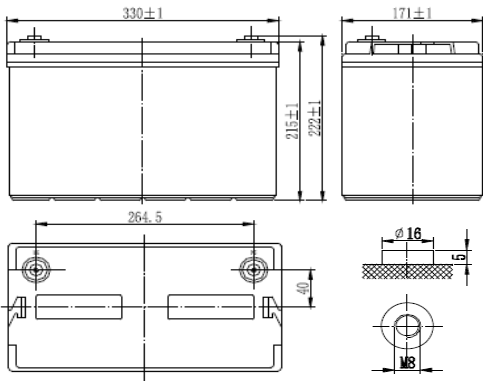

Specifications

Nominal Voltage		12V
Capacity (10hr@25°C@1.80V/C)		100Ah
Dimensions	Length	330mm (13.0inch)
	Width	171mm (6.73inch)
	Height	215mm (8.46inch)
	Total Height	222mm (8.74inch)
Approx. Weight		32.00kg (70.55lbs)
Maximum charging current		30.0A
Maximum discharge current		900A (5sec.)
Internal resistance		Approx. 4.5mΩ
Capacity affected by temperature (20hr)	40°C	103%
	25°C	100%
	0°C	86%
	-15°C	65%
Self-discharge (25°C)	3 month	Remaining Capacity: 91%
	6 month	Remaining Capacity: 82%
	12 month	Remaining Capacity: 65%
Nominal operating temperature		25°C ±3°C (77°F±5°F)
Operating temperature range		-20°C~55°C (-4°F~131°F)
Float charging voltage (25°C)		13.65 to 13.80V
Cyclic charging voltage (25°C)		14.40 to 15.00V
Terminal material		Copper

The Relationship for Charging Voltage and Temperature

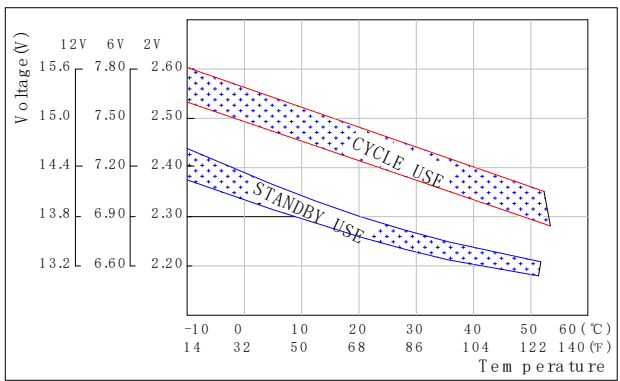

Charging Characteristics (25°C)

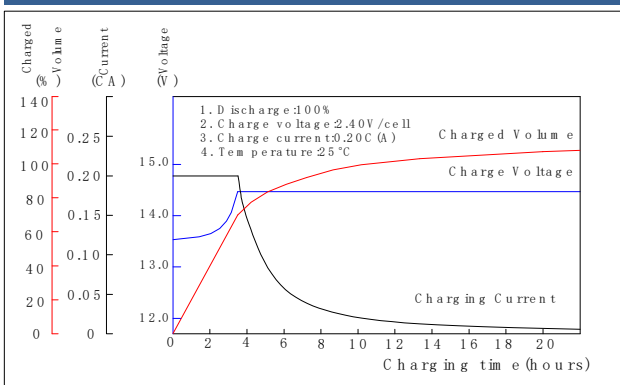

Discharge Characteristics (25°C)

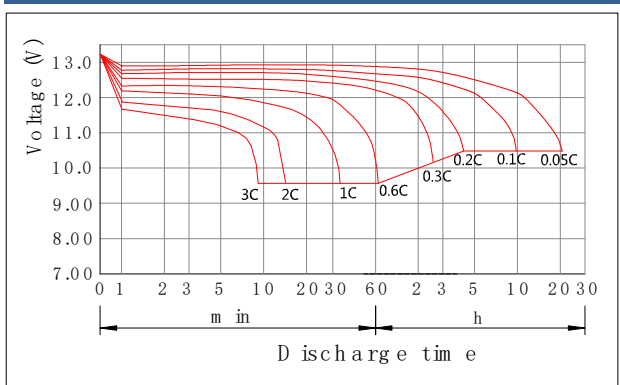

Constant Current Discharge Characteristics (Ampere / Battery, 25°C)

FV / TIME	5min	10min	15min	20min	30min	45min	1h	2h	3h	4h	5h	6h	8h	10h	20h
10.98V	--	167,81	145,50	126,10	91,67	67,90	58,88	32,30	23,38	19,59	16,68	14,36	11,45	9,70	5,14
10.80V	--	173,00	150,00	130,00	94,50	70,00	60,70	33,30	24,10	20,20	17,20	14,80	11,80	10,00	5,30
10.50V	--	188,00	161,00	135,00	96,50	71,30	61,60	35,30	24,80	21,00	17,60	15,10	12,10	10,10	5,35
10.20V	--	202,00	173,00	139,00	100,00	73,00	62,70	35,80	25,40	21,50	18,00	15,50	12,40	10,20	5,40
9.90V	--	218,00	182,00	143,00	104,00	78,70	63,70	36,40	25,90	21,80	18,30	15,70	12,50	10,30	5,43
9.60V	--	233,00	192,00	148,00	107,00	80,50	64,80	37,50	26,50	22,40	18,60	16,30	12,90	10,40	5,46

Constant Power Discharge Characteristics (Watt / Battery, 25°C)

FV / TIME	5min	10min	15min	20min	30min	45min	1h	2h	3h	4h	5h	6h	8h	10h	20h
10.98V	--	1885,68	1711,08	1309,50	1035,96	779,88	686,76	395,76	282,27	229,31	201,95	168,78	132,70	111,16	58,78
10.80V	--	1944,00	1764,00	1350,00	1068,00	804,00	708,00	408,00	291,00	236,40	208,20	174,00	136,80	114,60	60,60
10.50V	--	2076,00	1830,00	1416,00	1104,00	822,00	732,00	411,60	296,40	239,40	210,60	176,40	139,80	117,60	61,80
10.20V	--	2190,00	1896,00	1446,00	1140,00	840,00	756,00	419,40	300,00	246,00	211,80	180,00	142,80	120,00	62,40
9.90V	--	2316,00	1962,00	1512,00	1176,00	858,00	762,00	427,20	303,60	247,80	213,00	181,80	143,40	120,60	63,00
9.60V	--	2436,00	1992,00	1560,00	1212,00	882,00	774,00	435,00	306,60	253,20	214,20	183,60	145,20	121,80	63,60

Version: 2015-09