

RPower OGiV12120LP (12V 12Ah AGM Battery)

Floating Life at 20°C designed for 10-12 years

EAN: 4260349823319

Dimensions

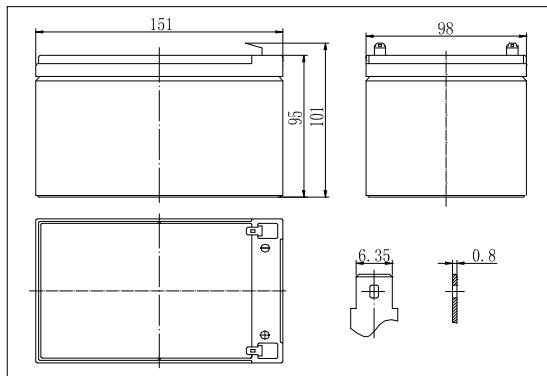

Specifications

Nominal Voltage		12V
Capacity (20hr@25°C@1.75V/C)		12Ah
Dimensions	Length	151mm (5.94inch)
	Width	98mm (3.86inch)
	Height	95mm (3.74inch)
	Total Height	101mm (3.98inch)
Approx. Weight		3.67kg (8.09lbs)
Maximum charging current		3.60A
Maximum discharge current		160A (5sec.)
Internal resistance		Approx. 17mΩ
Capacity affected by temperature (20hr)	40°C	103%
	25°C	100%
	0°C	86%
	-15°C	65%
Self-discharge (25°C)	3 month	Remaining Capacity: 91%
	6 month	Remaining Capacity: 82%
	12 month	Remaining Capacity: 65%
Nominal operating temperature		25°C ±3°C (77°F±5°F)
Operating temperature range		-20°C~55°C (-4°F~131°F)
Float charging voltage (25°C)		13.65 to 13.80V
Cyclic charging voltage (25°C)		14.40 to 15.00V
Terminal material		Copper

The Relationship for Charging Voltage and Temperature

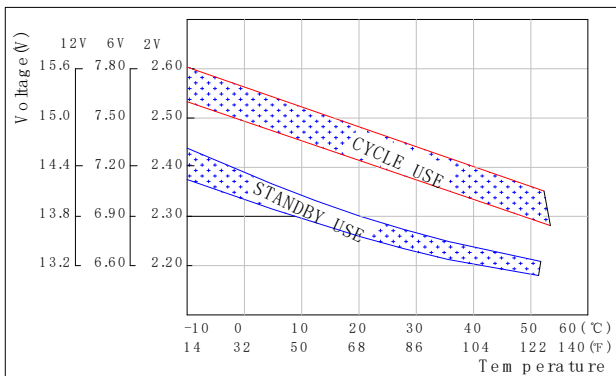

Charging Characteristics (25°C)

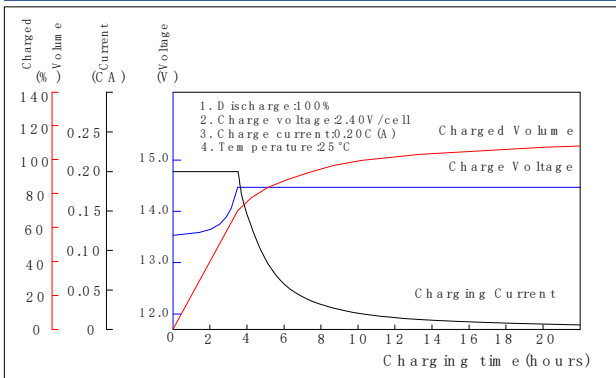

Discharge Characteristics (25°C)

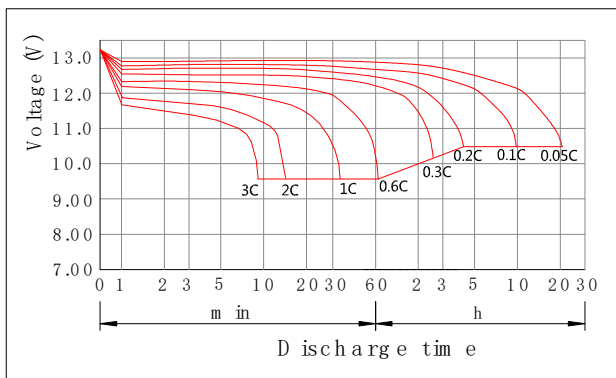

Constant Current Discharge Characteristics (Ampere / Battery, 25°C)

FV / TIME	5min	10min	15min	20min	30min	45min	1h	2h	3h	4h	5h	6h	8h	10h	20h
10.98V	39,38	27,35	21,92	16,78	12,32	8,73	7,52	3,94	2,97	2,21	1,96	1,61	1,31	1,09	0,57
10.80V	40,60	28,20	22,60	17,30	12,70	9,00	7,75	4,06	3,06	2,28	2,02	1,66	1,35	1,12	0,59
10.50V	42,10	29,00	23,20	17,70	13,00	9,10	7,86	4,10	3,09	2,35	2,05	1,69	1,37	1,14	0,60
10.20V	43,50	29,90	23,70	18,10	13,30	9,20	7,94	4,14	3,12	2,41	2,07	1,73	1,39	1,16	0,61
9.90V	45,00	30,80	24,30	18,50	13,50	9,30	8,04	4,19	3,15	2,48	2,10	1,78	1,41	1,17	0,61
9.60V	46,40	31,70	24,80	18,90	13,80	9,40	8,14	4,23	3,18	2,55	2,12	1,82	1,43	1,18	0,61

Constant Power Discharge Characteristics (Watt / Battery, 25°C)

FV / TIME	5min	10min	15min	20min	30min	45min	1h	2h	3h	4h	5h	6h	8h	10h	20h
10.98V	451,63	317,77	255,50	195,55	147,83	114,07	90,21	47,49	36,32	26,25	23,75	19,15	15,48	12,84	6,75
10.80V	465,60	327,60	263,40	201,60	152,40	117,60	93,00	48,96	37,44	27,06	24,48	19,74	15,96	13,24	6,96
10.50V	478,80	333,60	267,60	205,80	154,80	118,80	94,20	49,50	37,86	27,90	24,66	20,10	16,20	13,47	7,08
10.20V	491,40	339,60	271,80	210,60	157,20	120,60	94,80	49,98	38,22	28,62	24,84	20,58	16,44	13,71	7,20
9.90V	504,60	346,20	276,00	215,40	159,60	122,40	96,00	50,52	38,64	29,46	25,02	21,12	16,68	13,83	7,20
9.60V	517,20	352,20	280,20	219,60	162,00	123,60	96,60	51,00	39,00	30,30	25,20	21,60	16,92	13,95	7,26

Version: 2015-09