

SCHNITT C

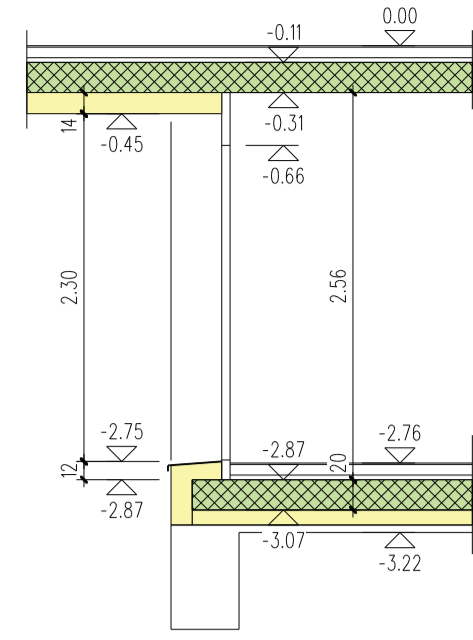

SCHNITT D

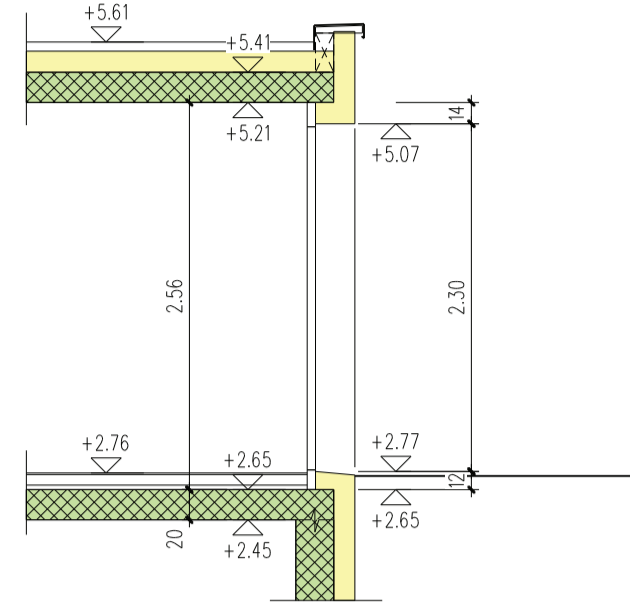

OBERGESCHOSS

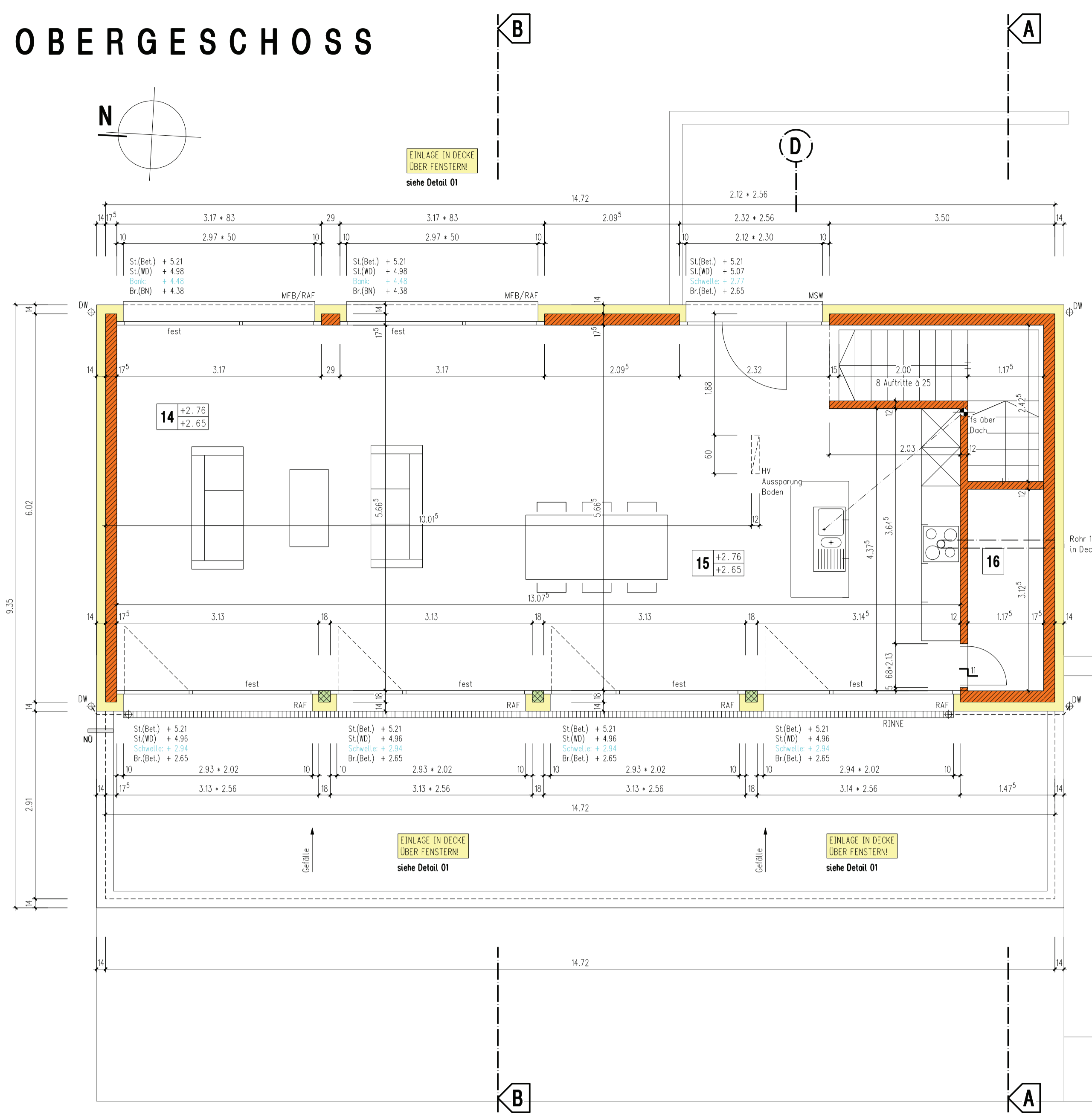

- WOHNEN**
- 14 12.76 / 12.65
- 15 12.76 / 12.65
- 16 12.65 / 12.65
- KÜCHE/ESSEN**
- 15 12.76 / 12.65
- 16 12.65 / 12.65
- REDUIT**
- 16 12.65 / 12.65

SCHNITT A-A

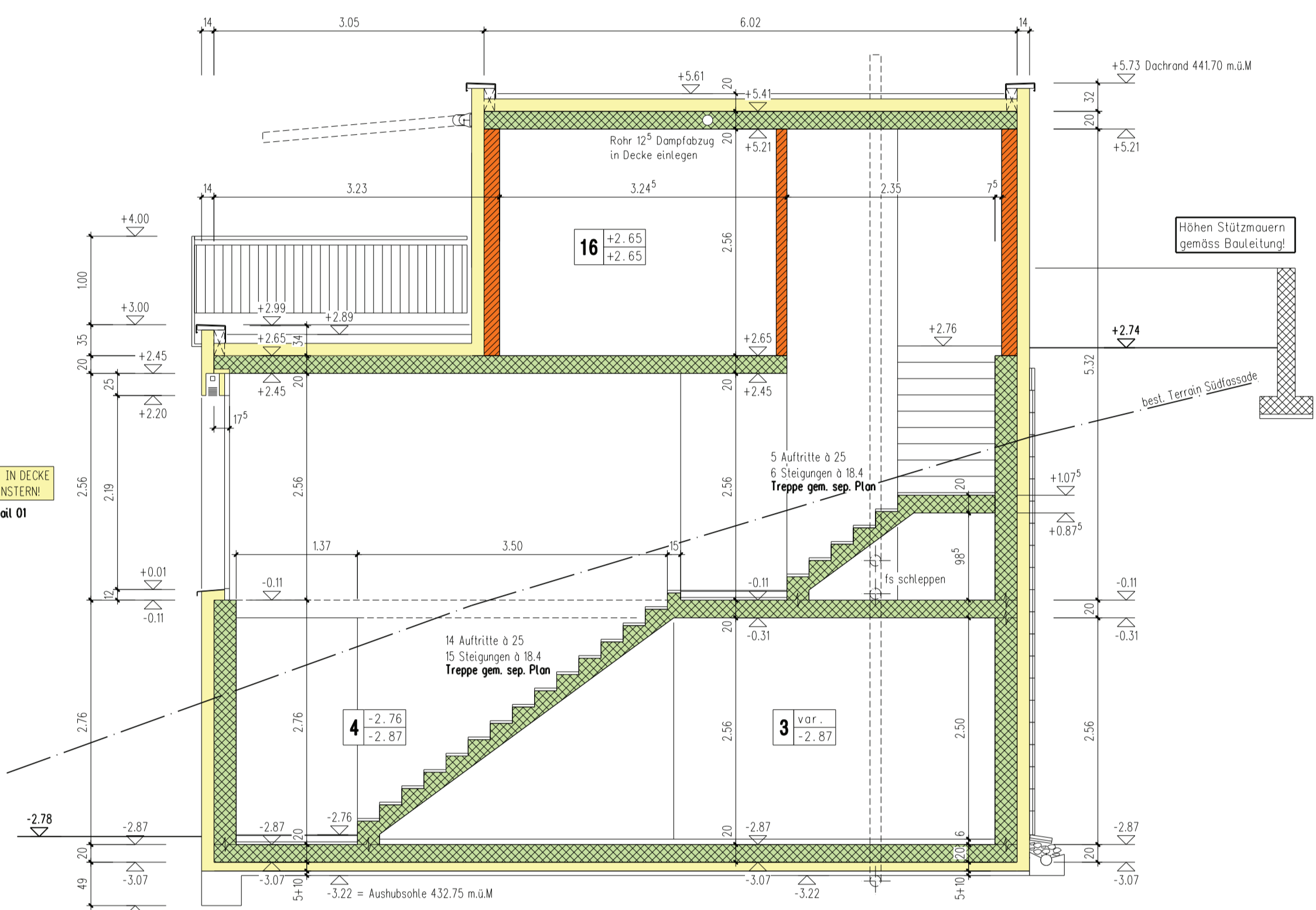

ERDGESCHOSS

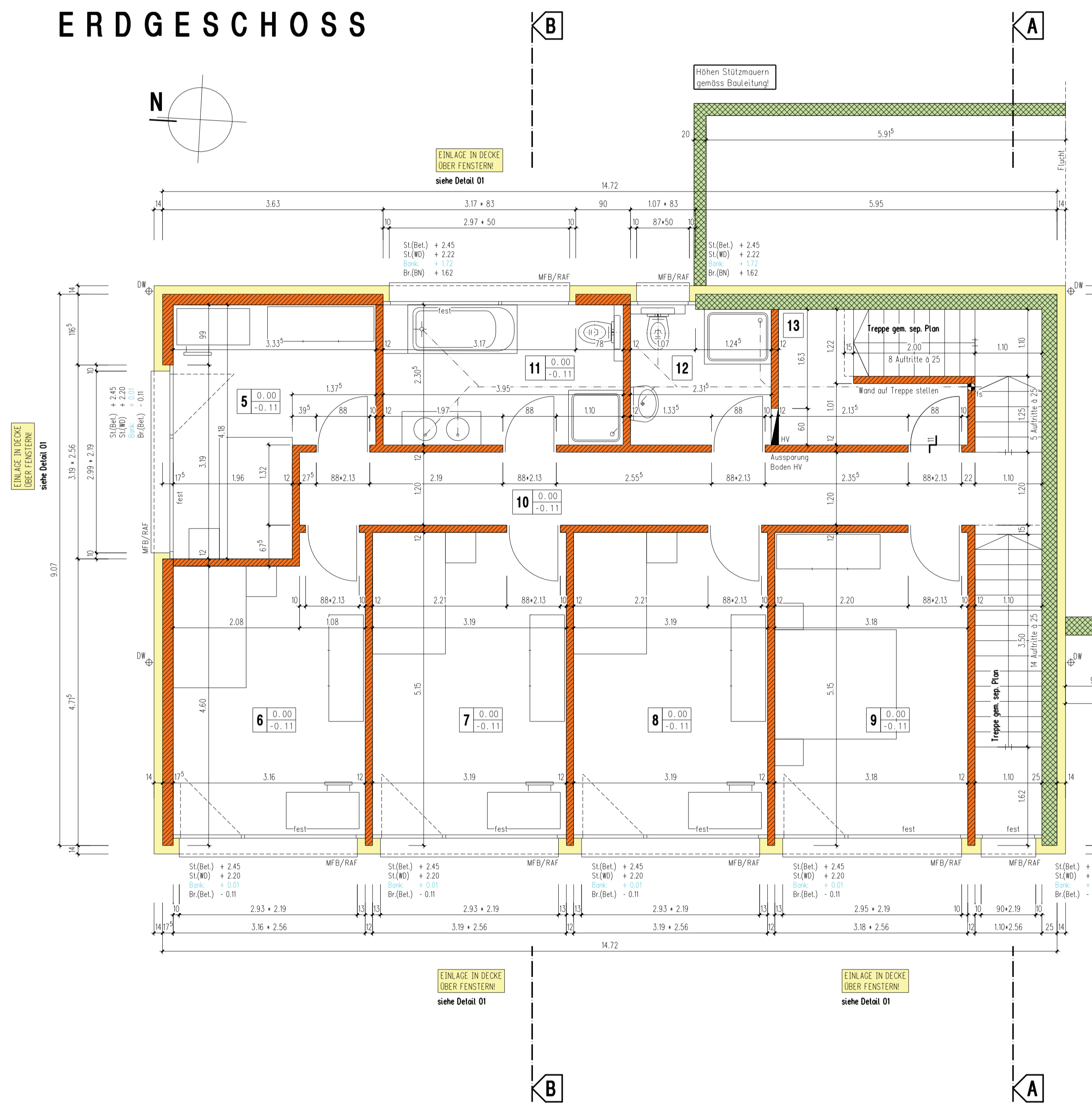

- ZIMMER 1**
- 5 0.00 / -0.11
- ZIMMER 2**
- 6 0.00 / -0.11
- ZIMMER 3**
- 7 0.00 / -0.11
- ZIMMER 4**
- 8 0.00 / -0.11
- ELTERN**
- 9 0.00 / -0.11
- GANG**
- 10 0.00 / -0.11
- BAD**
- 11 0.00 / -0.11
- WC**
- 12 0.00 / -0.11
- ABSTELLRAUM**
- 13 0.00 / -0.11

SCHNITT B-B

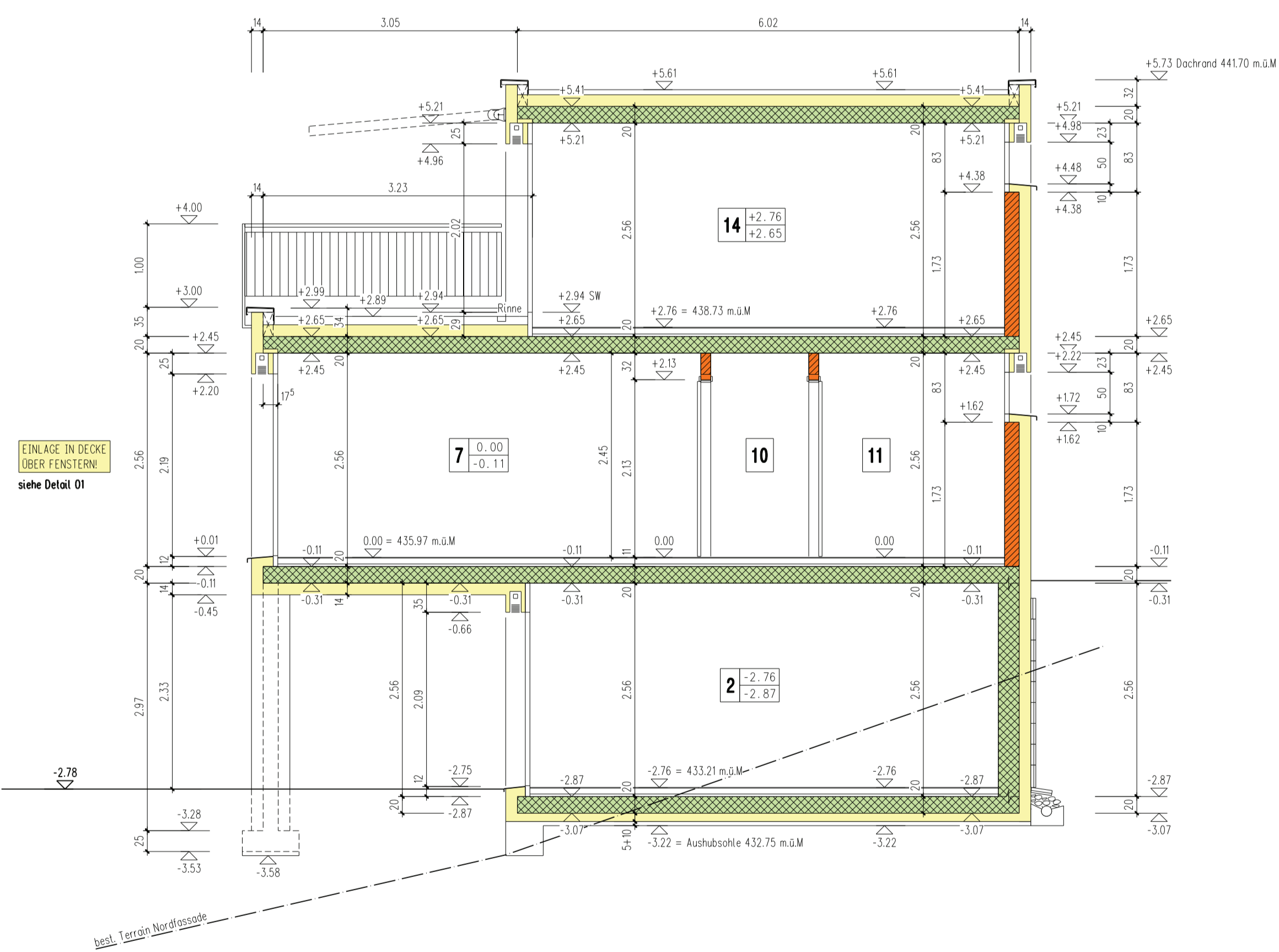

UNTERGESCHOSS

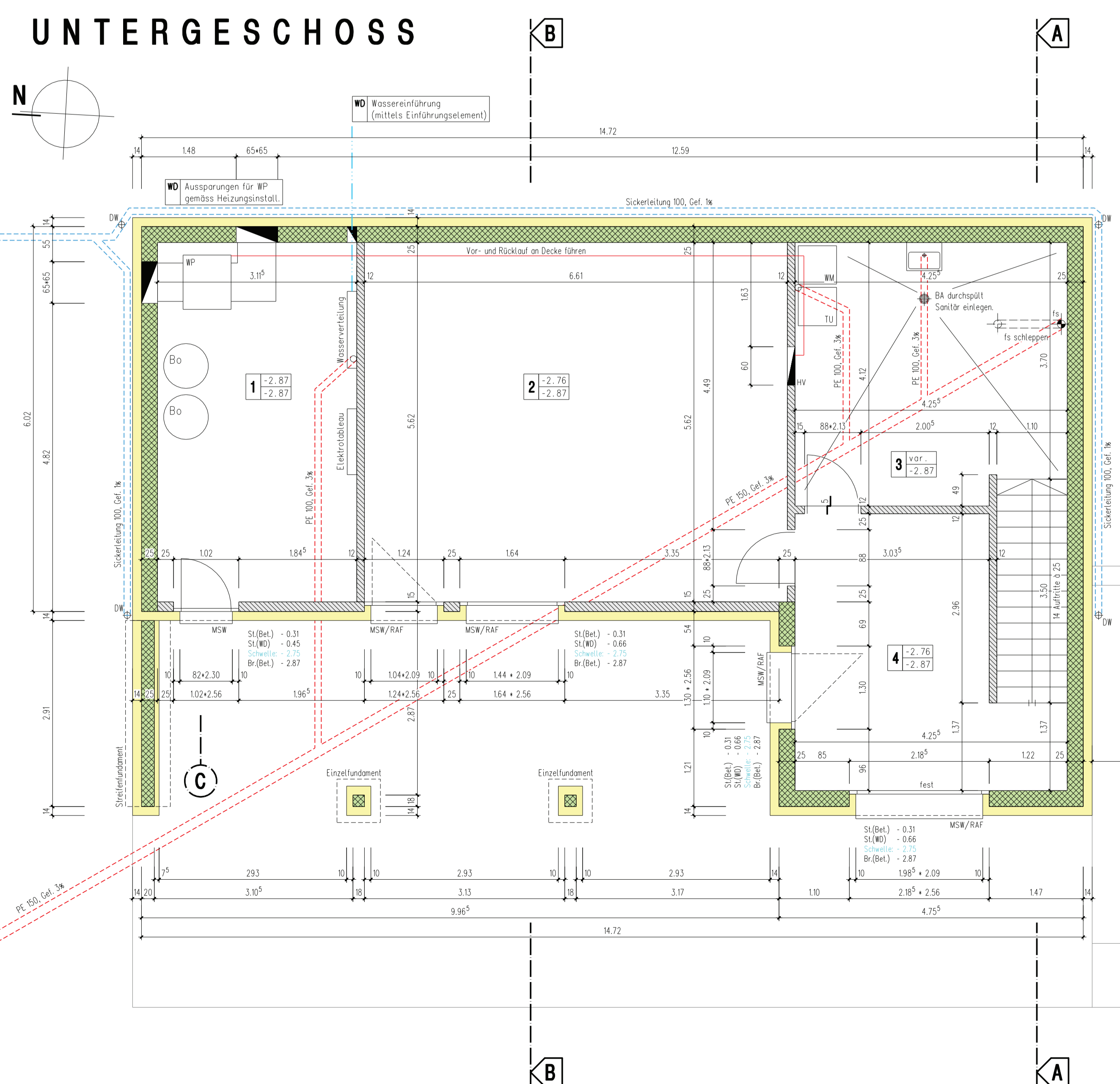

- TECHNIK**
- 1 2.87 / 2.87
- KELLER**
- 2 2.87 / 2.87
- WASCHEN**
- 3 2.87 / 2.87
- GANG**
- 4 2.87 / 2.87

DETAIL 01

